

密封处理超小型摇头开关 系列 A

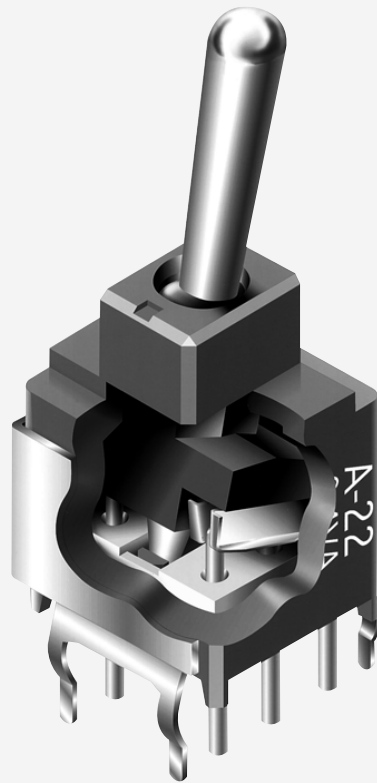

A
通用规格

电气容量 (电阻性负载)

微小功率: 最大0.4VA在最高28V AC/DC
(适用范围0.1mA~0.1A在20mV~28V)
注: 请参阅附录中关于运行范围更多说明。

其他额定参数

触点电阻: 最大50毫欧
绝缘电阻: 500兆欧以上在500V DC
绝缘强度: 触点间最低500V AC至少1分钟;
触点与外壳之间最低500V AC至少1分钟
机械寿命: 100,000次操作以上对于On-None-On和On-Off-On
50,000次操作以上对于其他电路
电气寿命: 50,000次操作以上
标称操作力: 1.47N(瞬间式); 1.18N(持续)对于.394" (10.0mm) 摇头开关
2.73N(瞬间式); 1.84N(持续)对于所有其他摇头开关
接触时间点: 非短路 (接触前先断开)
摆动角度: 26°

材质和涂覆

摇杆: 玻璃纤维增强聚酰胺用于防静电型; 黄铜镀镍用于所有其他型号
外壳: 玻璃纤维增强聚酰胺
支撑支架: 镀锡磷青铜
活动触点: 磷青铜镀金
固定触点: 黄铜镀金
端子: 黄铜镀金

环境数据

工作温度范围: -30°C到+85°C (-22°F到+185°F)
湿度: 240小时内40°C (104°F)时, 湿度90~95%
振动: 用1.5mm峰-峰振幅遍历10~55Hz频率范围, 并在1分钟内返回; 3个直角方向2小时
冲击: 50G (490m/s²) 加速度 (在6个直角方向上测试, 每个方向5次冲击)

印刷电路板处理

焊接: 建议采用波峰焊。请参阅附录中的概略图A。
手工焊接: 请参阅附录中的概略图B。
清洗: 自动清洗。请参阅附录中的清洗规格。

标准和认证

A系列摇头开关未经过UL认证或CSA认证测试。
这些开关为在低电压、低电流、微小功率电路中使用而设计。
当按原意图用于微小电流电路时, 其结果不会产生危险的能量。

主要特点

超小尺寸节省印刷电路板空间。

专为微小功率应用而设计。

整体密封处理结构防止触点污染，并为自动焊接和清洗节省时间与费用。

获奖的STC触点机构具有传统触点机构所不具备的如下优点：更加平滑、制动更可靠、触点稳定性更高、以及无与伦比的微小功率可靠性。（关于STC的术语和缩写的详情，请参阅附录目录。）

环氧树脂密封注塑的端子或超声波焊接的端子可阻止熔融物、溶剂、以及其他污染物侵入。

.100" x .100" (2.54mm x 2.54mm) 端子间距符合标准印刷电路板的格子间距。

可选择抗静电的摇杆以消除静电。

可供匹配的指示灯。

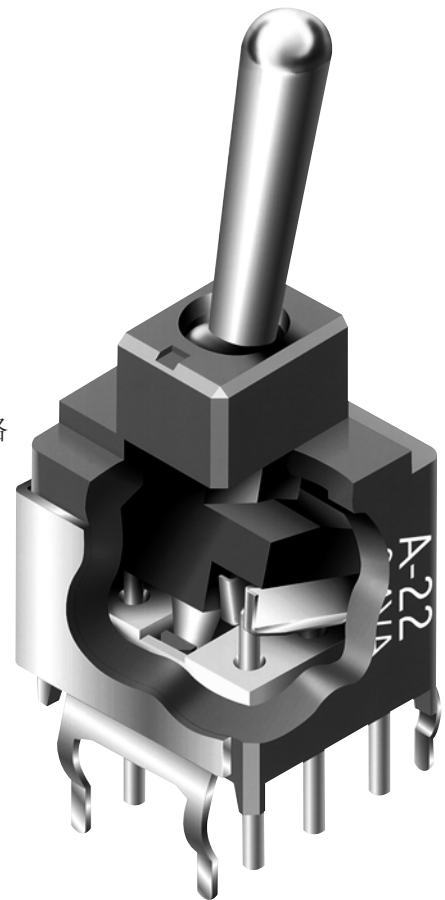

实际尺寸

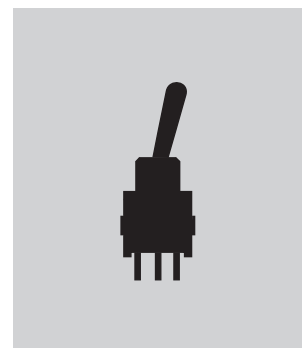

A	摇头开关
	翘板开关
	按钮开关
	发光按钮开关
	可编程开关
	钥匙锁开关
	旋转开关
	滑动开关
	触觉开关
	倾斜开关
	触觉开关
	指示灯
	附件
	附录

典型开关订购举例



典型订购举例

A12JV

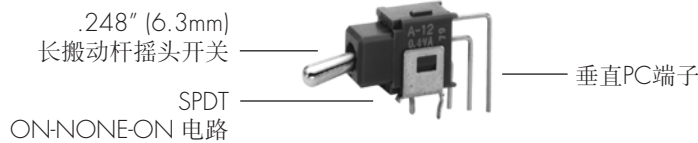

电极和电路

电极	型号	摇杆位置 () = 瞬间式			连接的端子			投掷及其示意图
		上	中	下	上	中	下	
								注: 端子编号并未实际印制在开关上。
SP	A11	OFF	NONE	ON	OPEN	OPEN	3-1	SPST
SP	A12 A13 A15 A1R A18 A19 A1S	ON ON ON (ON) (ON) ON (ON)	NONE OFF NONE NONE OFF OFF OFF	ON ON (ON) ON (ON) (ON) ON	2-3	OPEN	2-1	SPDT
DP	A22 A23 A25 A2R A28 A29 A2S	ON ON ON (ON) (ON) ON (ON)	NONE OFF NONE NONE OFF OFF OFF	ON ON (ON) ON (ON) (ON) ON	2-3 5-6	OPEN	2-1 5-4	DPDT

对于3掷 (3-on) 型

电极	型号	连接的端子和示意图			外部连接
		上	中	下	
SP	A24 A26 A27	ON (ON) ON 2-3 5-6	ON ON ON 2-3 5-4	ON (ON) (ON) 2-1 5-4	SP3T型使用双极基座。 在现场安装时必须 进行外部连接。

摇头开关

标准材质和涂覆: 黄铜镀镍抛光

J2的材质和涂覆: 消光涂覆黑色玻璃纤维增强聚酰胺

A .394" (10.0mm) 搬动杆

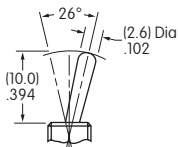

J .248" (6.3mm) 搬动杆

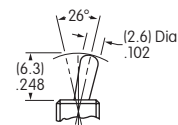

J2 .248" (6.3mm) 防静电搬动杆

耗散20Kv ESD: 直型PC端子

耗散10Kv ESD: 直型PC端子配有
支架、直角、以及垂直

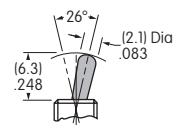

E .394" (10.0mm) 扁平的

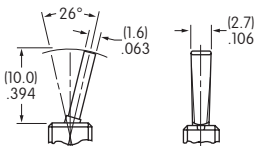

H .248" (6.3mm) 扁平的

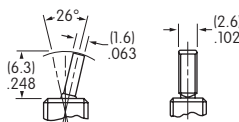

K 手柄的嵌入顶端

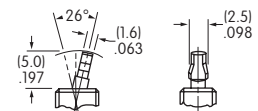

印刷电路端子

建议使用支撑支架以增加印刷电路板安装强度和稳定性。

P 直型

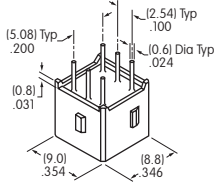

B 直型配有支架

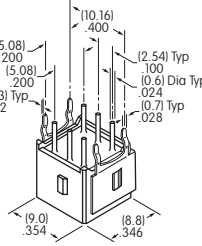

B1 直插单列支架
仅单极

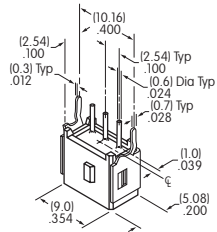

H 直角型配有支架

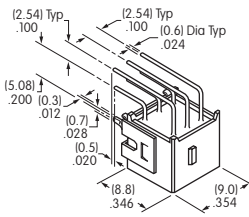

V 垂直型配有支架

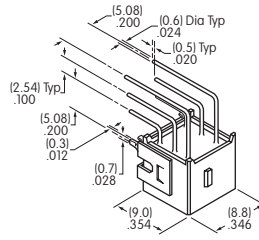

V1 垂直单列支架
仅单极

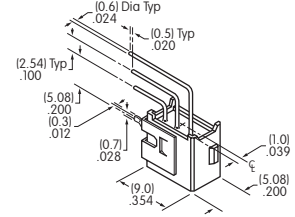

盖帽和扁手柄

G AT4003
.394" (10.0mm) 搬动杆盖帽

材质: PVC
可供颜色:
A, B, C

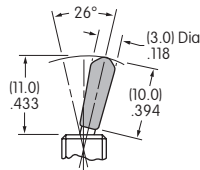

J AT4064
.248" (6.3mm) 搬动杆盖帽

材质: PVC
可供颜色:
A, B, C

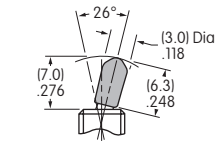

A AT467
短手柄

材质: 聚酰胺
可供颜色:
A, B, C, E, F, G, H

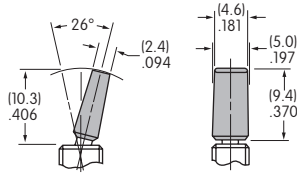

B AT468
长手柄

材质: 聚酰胺
可供颜色:
A, B, C, E, F, G, H

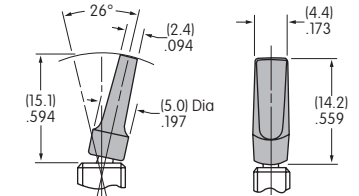

颜色编号:

- A** 黑
- B** 白
- C** 红
- E** 黄
- F** 绿
- G** 蓝
- H** 灰

典型开关尺寸

单极

直型PC端子

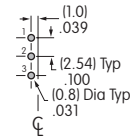
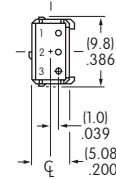
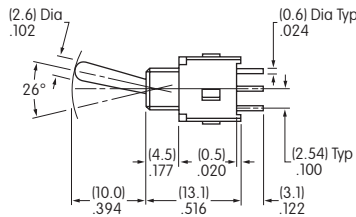
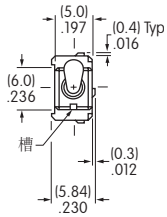

A11型没有端子2

A12AP

双极

直型PC端子

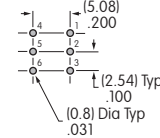
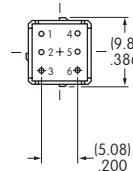
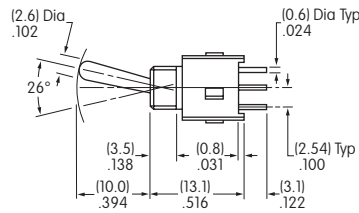
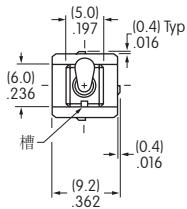

A22AP

单极

直型PC端子·支架

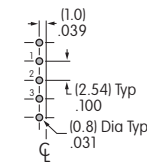
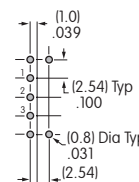
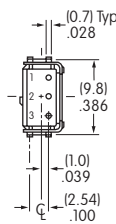
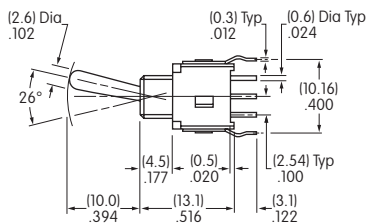
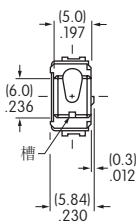

B端子

B1端子

A12AB

双极

直型PC端子·支架

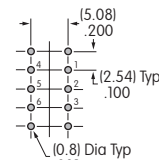
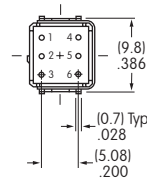
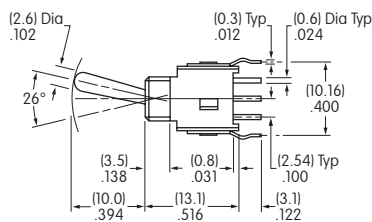
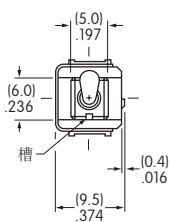

A22AB

- A 摇头开关
- 翘板开关
- 按钮开关
- 发光按钮开关
- 可编程开关
- 钥匙锁开关
- 旋转开关
- 滑动开关
- 触觉开关
- 倾斜开关
- 触觉开关
- 指示灯
- 附件
- 附录

典型开关尺寸

直角PC端子

单极

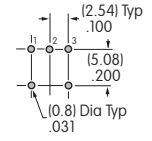
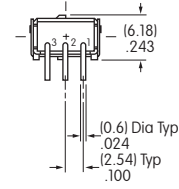
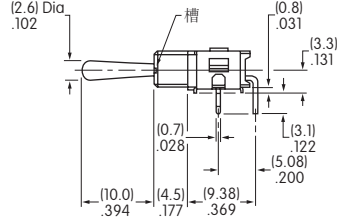
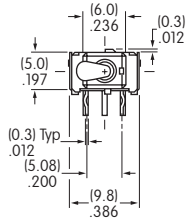

A12AH

直角PC端子

双极

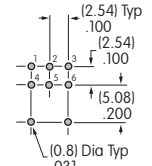
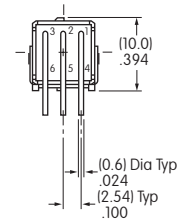
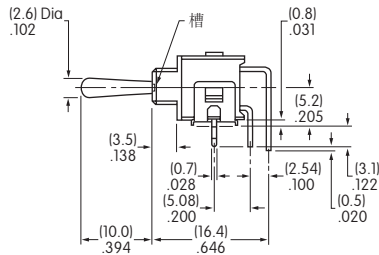
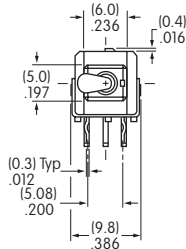

A22AH

垂角PC端子

单极

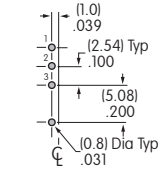
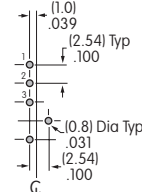
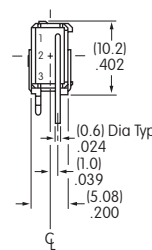
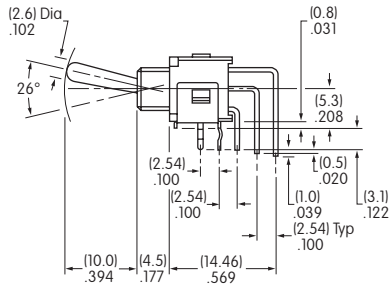
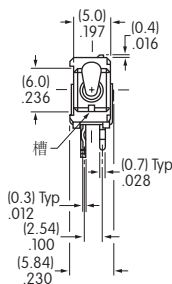

A12AV

V端子

V1端子

垂角PC端子

双极

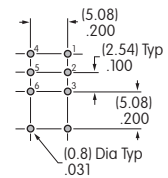
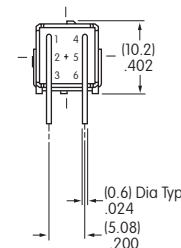
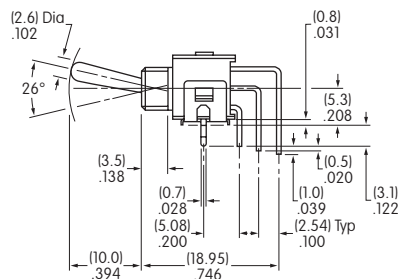
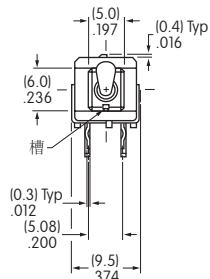

A22AV

摇头开关

翘板开关

按钮开关

发光按钮开关

可编程开关

钥匙锁开关

旋转开关

滑动开关

触觉开关

倾斜开关

触觉开关

指示灯

附件

附录

SANPUM

为高端制造业提供一流的工业产品

SANPUM

深圳市三浦贸易有限公司

地址：深圳市南山区南海大道海王大厦A座19E

电话：86-755-23881000

传真：86-755-23881777

邮箱：info@sanpum.com



4008 824 824
WWW.SANPUM.COM